

Varenummer: 0106042  
 Beskrivelse: Seeger låsering JV 25

## Mål

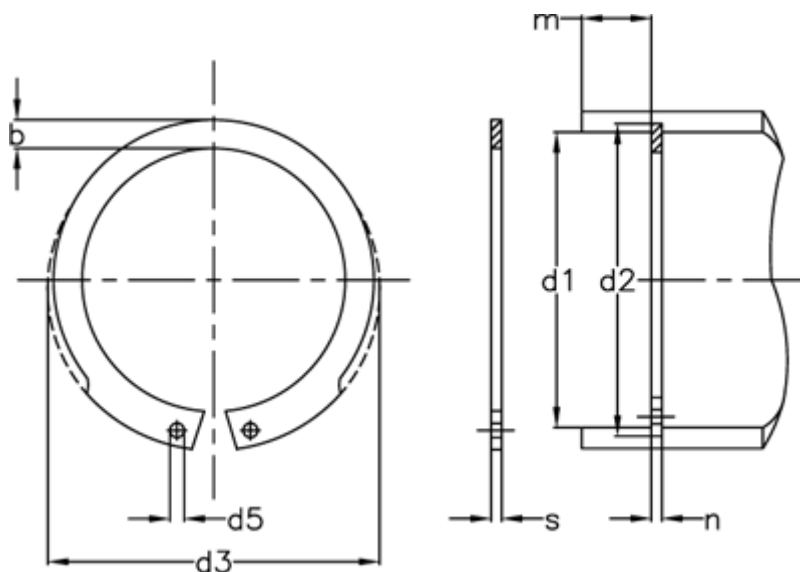

AN mm <sup>2</sup>	= 24	FRg kN	= 5.0	Tang	= ZGJ-1
b	= 2.8	FR kN	= 14.8	tol	= -0.06
Betegnelse	= JV 25	g	= 1.0	tol	= +0,42-0,21
d1	= 25	K kN-mm	= 30.6	tol	= +0,21
d2	= 26.2	m min	= 1.30	tol	= 0.1
d3	= 26.9	Nominel træk	= 1.8	vægt kg/1000	= 1.40
d5 min	= 1.5	s	= 1.20		
FN kN	= 4.00	t	= 0.60		